

PR
electronics



5 7 1 5

**Programmable
LED Indicator**

No. 5715V102-UK
From serial number:
121496001 (B)
131077001 (D)



SIGNALS THE BEST

- DK** ▶ PR electronics A/S tilbyder et bredt program af analoge og digitale signalbehandlingsmoduler til industriel automation. Programmet består af Isolatorer, Displays, Ex-barrierer, Temperaturtransmittere, Universaltransmittere mfl. Vi har modulerne, du kan stole på i selv barske miljøer med elektrisk støj, vibrationer og temperaturudsving, og alle produkter opfylder de strengeste internationale standarder. Vores motto »Signals the Best« er indbegrebet af denne filosofi – og din garanti for kvalitet.
- UK** ▶ PR electronics A/S offers a wide range of analogue and digital signal conditioning devices for industrial automation. The product range includes Isolators, Displays, Ex Interfaces, Temperature Transmitters, and Universal Devices. You can trust our products in the most extreme environments with electrical noise, vibrations and temperature fluctuations, and all products comply with the most exacting international standards. »Signals the Best« is the epitome of our philosophy – and your guarantee for quality.
- FR** ▶ PR electronics A/S offre une large gamme de produits pour le traitement des signaux analogiques et numériques dans tous les domaines industriels. La gamme de produits s'étend des transmetteurs de température aux afficheurs, des isolateurs aux interfaces SI, jusqu'aux modules universels. Vous pouvez compter sur nos produits même dans les conditions d'utilisation sévères, p.ex. bruit électrique, vibrations et fluctuations de température. Tous nos produits sont conformes aux normes internationales les plus strictes. Notre devise »SIGNALS the BEST« c'est notre ligne de conduite - et pour vous l'assurance de la meilleure qualité.
- DE** ▶ PR electronics A/S verfügt über ein breites Produktprogramm an analogen und digitalen Signalverarbeitungsgeräte für die industrielle Automatisierung. Dieses Programm umfasst Displays, Temperaturtransmitter, Ex- und galvanische Signaltrenner, und Universalgeräte. Sie können unsere Geräte auch unter extremen Einsatzbedingungen wie elektrisches Rauschen, Erschütterungen und Temperaturschwingungen vertrauen, und alle Produkte von PR electronics werden in Übereinstimmung mit den strengsten internationalen Normen produziert. »Signals the Best« ist Ihre Garantie für Qualität!

PROGRAMMABLE LED INDICATOR

5715

CONTENTS

Warning	2
Symbol identification.....	2
Safety instructions.....	3
Declaration of conformity.....	5
Front and back layout	6
Application	7
Technical characteristics	7
Mounting / installation.....	7
Applications.....	8
Order: 5715	9
Electrical specifications.....	9
Sensor error detection inside and outside range.....	13
Connections	14
Block diagram	15
Routing diagram.....	17
Scrolling help texts.....	18
Configuration / operating the function keys	20
Programming via PC	21
Graphic depiction of the relay function setpoint.....	21



GENERAL

WARNING

This module is designed for connection to hazardous electric voltages. Ignoring this warning can result in severe personal injury or mechanical damage. To avoid the risk of electric shock and fire, the safety instructions of this manual must be observed and the guidelines followed. The specifications must not be exceeded, and the module must only be applied as described in the following. Prior to the commissioning of the module, this manual must be examined carefully. Only qualified personnel (technicians) should install this module.

If the equipment is used in a manner not specified by the manufacturer, the protection provided by the equipment may be impaired.



**HAZARD-
OUS
VOLTAGE**

WARNING

Until the module is fixed, do not connect hazardous voltages to the module.

The following operations should only be carried out on a disconnected module and under ESD safe conditions:

Troubleshooting the module.

Repair of the module must be done by PR electronics A/S only.



SYMBOL IDENTIFICATION



Triangle with an exclamation mark: Warning / demand. Potentially lethal situations.



The CE mark proves the compliance of the module with the essential requirements of the directives.

SAFETY INSTRUCTIONS

DEFINITIONS

Hazardous voltages have been defined as the ranges: 75 to 1500 Volt DC, and 50 to 1000 Volt AC.

Technicians are qualified persons educated or trained to mount, operate, and also troubleshoot technically correct and in accordance with safety regulations. Operators, being familiar with the contents of this manual, adjust and operate the knobs or potentiometers during normal operation.

RECEIPT AND UNPACKING

Unpack the device without damaging it. The packing should always follow the device until this has been permanently mounted. Check at the receipt of the device whether the type corresponds to the one ordered.

ENVIRONMENT

Avoid direct sunlight, dust, high temperatures, mechanical vibrations and shock, as well as rain and heavy moisture. If necessary, heating in excess of the stated limits for ambient temperatures should be avoided by way of ventilation.

All modules fall under Installation Category II, Pollution Degree 1, and Insulation Class II.

MOUNTING

Only technicians who are familiar with the technical terms, warnings, and instructions in the manual and who are able to follow these should connect the module.

Should there be any doubt as to the correct handling of the module, please contact your local distributor or, alternatively,

PR electronics A/S
www.prelectronics.com

Mounting and connection of the module should comply with national legislation for mounting of electric materials, i.e. wire cross section, protective fuse, and location. Descriptions of Input / Output and supply connections are shown in the block diagram and side label.

The following apply to fixed hazardous voltages-connected modules:

The max. size of the protective fuse is 10 A and, together with a power switch, it should be easily accessible and close to the module. The power switch should be marked with a label telling it will switch off the voltage to the module.

UL INSTALLATION REQUIREMENTS

For use on a flat surface of a type 1 enclosure

Use 60/75°C copper conductors only

Enclosure rating (face only).....	Type 4X, UL50E
Max. ambient temperature.....	60°C
Max. wire size, pins 41...46.....	AWG 30-16
Max. wire size, others	AWG 30-12
UL file number.....	E248256

CALIBRATION AND ADJUSTMENT

During calibration and adjustment, the measuring and connection of external voltages must be carried out according to the specifications of this manual. The technician must use tools and instruments that are safe to use.

NORMAL OPERATION

Operators are only allowed to adjust and operate modules that are safely fixed in panels, etc., thus avoiding the danger of personal injury and damage. This means there is no electrical shock hazard, and the module is easily accessible.

CLEANING

When disconnected, the module may be cleaned with a cloth moistened with distilled water.

LIABILITY

To the extent the instructions in this manual are not strictly observed, the customer cannot advance a demand against PR electronics A/S that would otherwise exist according to the concluded sales agreement.

DECLARATION OF CONFORMITY

As manufacturer

PR electronics A/S

Lerbakken 10

DK-8410 Rønede

hereby declares that the following product:

Type: 5715

Name: Programmable LED indicator

is in conformity with the following directives and standards:

The EMC Directive 2004/108/EC and later amendments

EN 61326-1

For specification of the acceptable EMC performance level, refer to the electrical specifications for the module.

The Low Voltage Directive 2006/95/EC and later amendments

EN 61010-1

Rønede, 17 December 2009



Kim Rasmussen
Manufacturer's signature

FRONT AND BACK LAYOUT



Picture 1: Front of PReview 5715.

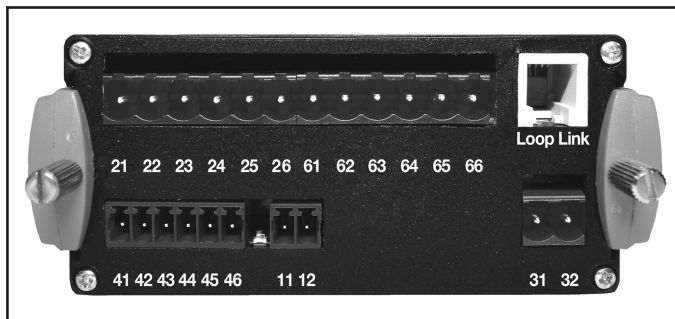

Picture 2: Back of PReview 5715.

PROGRAMMABLE LED INDICATOR

PREVIEW 5715

- *4-digit 14-segment LED display*
- *Input for mA, V, potentiometer, Ohm, RTD and TC*
- *4 relays and analogue output*
- *Universal supply*
- *Programmable via front keys and PC*

Application

- Display for digital readout of current / voltage / resistance / temperature or 3-wire potentiometer signals.
- Process control with 4 pairs of potential-free change-over relays and analogue output.
- For tank level control, with the possibility of customer linearisation ensuring correct level measurement and control in non-linear tanks.

Technical characteristics

- 4-digit LED indicator with 13.8 mm 14-segment characters. Max. display readout -1999...9999 with programmable decimal point and relay ON / OFF indication.
- All standard operational parameters can be adjusted to any application by way of the front function keys. When programming is carried out by way of a PC and the configuration program PReset, additional configuration options are available, such as customer-defined linearisation and special input signals.
- Help texts in eight languages can be selected via a menu item.
- A menu item allows the user to minimise the installation test time for the relay outputs by activating/deactivating each relay independently of the input signal.

Mounting / installation

- To be mounted in panel front. The included rubber packing must be mounted between the panel cutout hole and the display front to obtain a protection degree of IP65 (type 4X). For extra protection in extreme environments, PReview 5715 can be delivered with a specially designed splash-proof cover as accessory.

APPLICATIONS

Input signals:

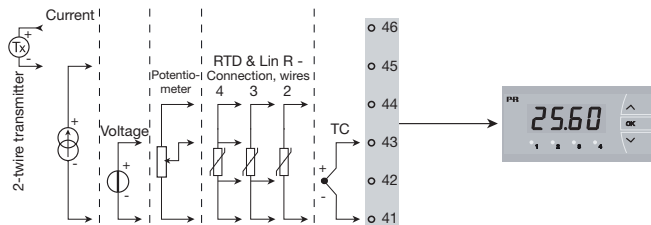

Output signals:

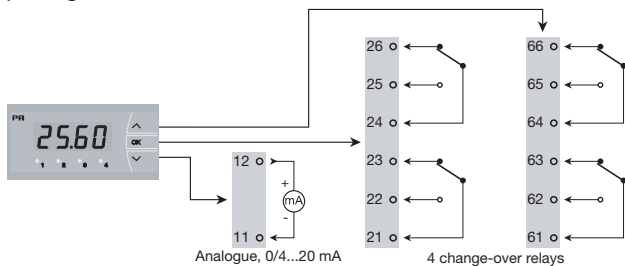

Supply:

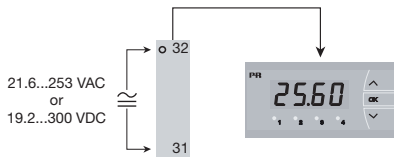

Order: 5715

Type	Version
5715	4 relays : B Analogue output and 4 relays . . : D

Electrical specifications

Specifications range:

-20°C to +60°C

Common specifications:

Supply voltage, universal 21.6...253 VAC, 50...60 Hz or
19.2...300 VDC

Consumption:

Type	Internal consumption	Max. consumption
5715B	3.0 W	3.3 W
5715D	3.5 W	3.8 W

Isolation voltage, test / operation 2.3 kVAC / 250 VAC

Signal / noise ratio Min. 60 dB (0...100 kHz)

Communications interface USB Loop Link

Response time (0...90%, 100...10%):

Temperature input..... < 1 s

Current / voltage input..... < 400 ms

Calibration temperature..... 20...28°C

Accuracy, the greater of general and basic values:

General values		
Input type	Absolute accuracy	Temperature coefficient
All	≤ ±0.1% of reading	≤ ±0.01% of reading / °C

Basic values		
Input type	Basic accuracy	Temperature coefficient
mA	$\leq \pm 4 \mu\text{A}$	$\leq \pm 0.4 \mu\text{A} / ^\circ\text{C}$
Volt	$\leq \pm 20 \mu\text{V}$	$\leq \pm 2 \mu\text{V} / ^\circ\text{C}$
Pt100	$\leq \pm 0.2^\circ\text{C}$	$\leq \pm 0.01^\circ\text{C} / ^\circ\text{C}$
Linear resistance	$\leq \pm 0.1 \Omega$	$\leq \pm 0.01 \Omega / ^\circ\text{C}$
Potentiometer	$\leq \pm 0.1 \Omega$	$\leq \pm 0.01 \Omega / ^\circ\text{C}$
TC type: E, J, K, L, N, T, U	$\leq \pm 1^\circ\text{C}$	$\leq \pm 0.05^\circ\text{C} / ^\circ\text{C}$
TC type: R, S, W3, W5, LR	$\leq \pm 2^\circ\text{C}$	$\leq \pm 0.2^\circ\text{C} / ^\circ\text{C}$
TC type: B 85...200°C	$\leq \pm 4^\circ\text{C}$	$\leq \pm 0.4^\circ\text{C} / ^\circ\text{C}$
TC type: B 200...1820°C	$\leq \pm 2^\circ\text{C}$	$\leq \pm 0.2^\circ\text{C} / ^\circ\text{C}$

EMC immunity influence < $\pm 0,5\%$ of reading

Auxiliary supply:

2-wire supply (pin 46...45)	25...15 VDC / 0...20 mA / 30 mA nom
Wire size, pin 41...46 (max.)	1 x 1.5 mm ² stranded wire
Wire size, others (max.)	1 x 2.5 mm ² stranded wire
Relative humidity	< 95% RH (non cond.)
Dimensions (HxBxD)	48 x 96 x 120 mm
Cutout dimensions	44.5 x 91.5 mm
Protection degree (mounted in panel)	IP65 / Type 4X, UL50E
Weight	260 g

RTD, linear resistance and potentiometer input:

Input type	Min. value	Max. value	Standard
Pt10...Pt1000	-200°C	+850°C	IEC 60751
Ni50...Ni1000	-60°C	+250°C	DIN 43760
Cu10...Cu100	-200°C	+260°C	$\alpha = 0.00427$
Lin. R	0 Ω	10000 Ω	-
Potentiometer	10 Ω	100 k Ω	-

Input for RTD types:

Pt10, Pt20, Pt50, Pt100, Pt200, Pt250, Pt300, Pt400, Pt500, Pt1000
Ni50, Ni100, Ni120, Ni1000, Cu10, Cu20, Cu50, Cu100

Cable resistance per wire, RTD (max.)..... 50 Ω
 Sensor current, RTD..... Nom. 0.2 mA
 Effect of sensor cable resistance
 (3- / 4-wire), RTD..... < 0.002 Ω / Ω
 Sensor error detection, RTD Yes
 Short circuit detection, RTD..... < 15 Ω

TC input:

Type	Min. value	Max. value	Standard
B	+0°C	+1820°C	IEC 60584-1
E	-100°C	+1000°C	IEC 60584-1
J	-100°C	+1200°C	IEC 60584-1
K	-180°C	+1372°C	IEC 60584-1
L	-200°C	+900°C	DIN 43710
N	-180°C	+1300°C	IEC 60584-1
R	-50°C	+1760°C	IEC 60584-1
S	-50°C	+1760°C	IEC 60584-1
T	-200°C	+400°C	IEC 60584-1
U	-200°C	+600°C	DIN 43710
W3	0°C	+2300°C	ASTM E988-90
W5	0°C	+2300°C	ASTM E988-90
LR	-200°C	+800°C	GOST 3044-84

Cold junction compensation (CJC)

via internal sensor..... $\pm(2.0^{\circ}\text{C} + 0.4^{\circ}\text{C} * \Delta t)$

Δt = internal temperature - ambient temperature

Sensor error detection, all TC types Yes

Sensor error current:

when detecting Nom. 2 μA

else..... 0 μA

Current input:

Measurement range 0...20 mA

Programmable measurement ranges..... 0...20 and 4...20 mA

Input resistance..... Nom. 20 Ω + PTC 25 Ω

Sensor error detection:

loop break 4...20 mA Yes

Voltage input:

Measurement range 0...12 VDC

Programmable measurement ranges..... 0...1, 0.2...1,
0...10 and 2...10 VDC

Input resistance..... Nom. 10 M Ω

Outputs:

Display:

Display readout	-1999...9999 (4 digits)
Decimal point	Programmable
Digit height	13.8 mm
Display updating	2.2 times / s
Input outside input range is indicated by	Explanatory text

Current output:

Signal range (span).....	0...20 mA
Programmable signal ranges	0...20, 4...20, 20...0 and 20...4 mA
Load (max.).....	20 mA / 800 Ω / 16 VDC
Load stability	$\leq 0.01\%$ of span / 100 Ω
Sensor error detection	23 / 0 / 3.5 mA / none
NAMUR NE 43 Up- / Downscale	23 mA / 3.5 mA
Output limitation:	
on 4...20 and 20...4 mA signals.....	3,8...20.5 mA
on 0...20 and 20...0 mA signals.....	0...20.5 mA
Current limit.....	≤ 28 mA

Relay outputs:

Relay function.....	Setpoint
Hysteresis.....	0...100%
On and Off delay	0...3600 s
Sensor error detection	Make / Break / Hold
Max. voltage.....	250 VRMS
Max. current	2 A / AC
Max. AC power	500 VA
Max. current at 24 VDC.....	1 A

Marine approval:

Det Norske Veritas, Ships & Offshore	Standard for Certification No. 2.4
--	------------------------------------

GOST R approval:

VNIIM, Cert. no.....	See www.prelectronics.com
----------------------	--

Observed authority requirements:

Standard:

EMC 2004/108/EC	EN 61326-1
LVD 2006/95/EC.....	EN 61010-1
UL, Standard for Safety	UL 508

Sensor error detection inside and outside range

Sensor error check in 5715 variants:		
Variant:	Configuration	Sensor error detection:
5715B	ERR1, ERR2, ERR3 and ERR4 = NONE	OFF
	Else:	ON
5715D	ERR1, ERR2, ERR3 and ERR4=NONE, O.ERR=NONE.	OFF
	Else:	ON

Outside range readout (IN.LO, IN.HI): If the valid range of the A/D converter or the polynomial is exceeded			
Input	Range	Readout	Limit
VOLT	0...1 V / 0,2...1 V	IN.LO	< -25 mV
		IN.HI	> 1,2 V
	0...10 V / 2...10 V	IN.LO	< -25 mV
		IN.HI	> 12 V
CURR	0...20 mA / 4...20 mA	IN.LO	< -1,05 mA
		IN.HI	> 25,05 mA
POTM	-	IN.LO	< -0,5%
		IN.HI	> 100,5%
TEMP	TC / RTD	IN.LO	< temperature range -2°C
		IN.HI	> temperature range +2°C
LIN R	0...800 ohm	IN.LO	< 0 ohm
		IN.HI	> 1 kohm
	0...10 kohm	IN.LO	< 0 ohm
		IN.HI	> 15 kohm

Sensor error detection (SE.BR, SE.SH):			
Input	Range	Readout	Limit
CURR	Loop break (4..20mA)	SE.BR	<= 3,6 mA; > = 21 mA
		SE.BR	> ca. 750 kohm / (1,25 V)
TEMP	RTD, 2-, 3- & 4-wire No SE.SH for Cuxx, Pt10, Pt20 & Pt50	SE.BR	> 12 kohm
		SE.SH	< 15 ohm
		SE.BR	> 875 ohm
LIN R	0...800 ohm	SE.BR	> 875 ohm
	0...10 kohm	SE.BR	> 12 kohm

Display readout below min. / above max. (-1.9.9.9, 9.9.9.9):			
Input	Range	Readout	Limit
CURR / VOLT / Lin R	All	-1.9.9.9	Display readout <-1999
		9.9.9.9	Display readout >9999
POTM	-	-1.9.9.9	Display readout <-1999
		9.9.9.9	Display readout >9999

Readout at hardware error ! Error indications in the display blink once a second. The help text explains the error		
Error search	Readout	Error cause
Test of internal communication uC / ADC	HW.ER	Permanent error in ADC
Test of internal CJC sensor	CJ.ER	CJC sensor defect
Check-sum test of the configuration in RAM	RA.ER	Error in RAM
Check-sum test of the configuration in EEPROM	EE.ER	Error in EEPROM

CONNECTIONS

Supply:

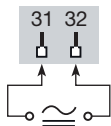

Inputs:

RTD & Lin R, 2-wire

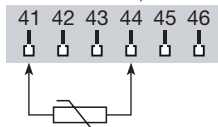

RTD & Lin R, 3-wire

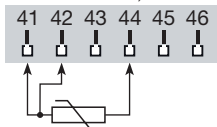

RTD & Lin R, 4-wire

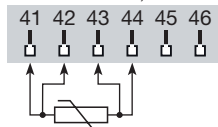

TC

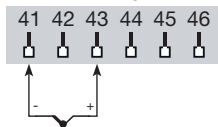

2-wire transmitter

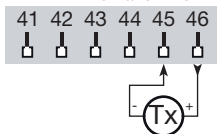

Current

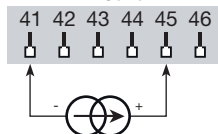

Voltage

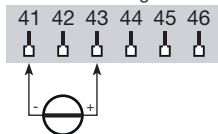

Potentiometer

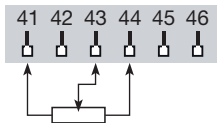

Output:

Current

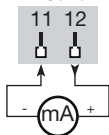

Relays

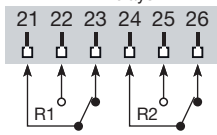

Relays

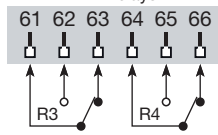

BLOCK DIAGRAM

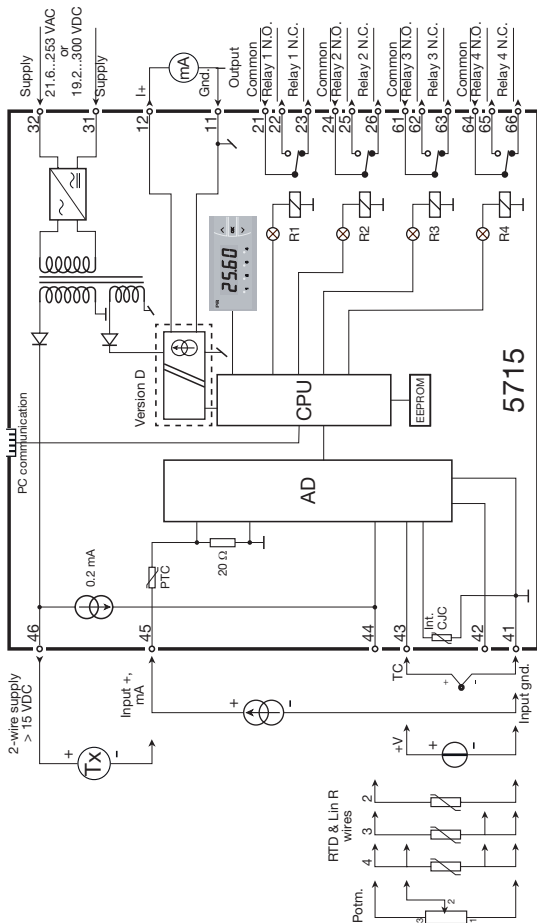

Power up

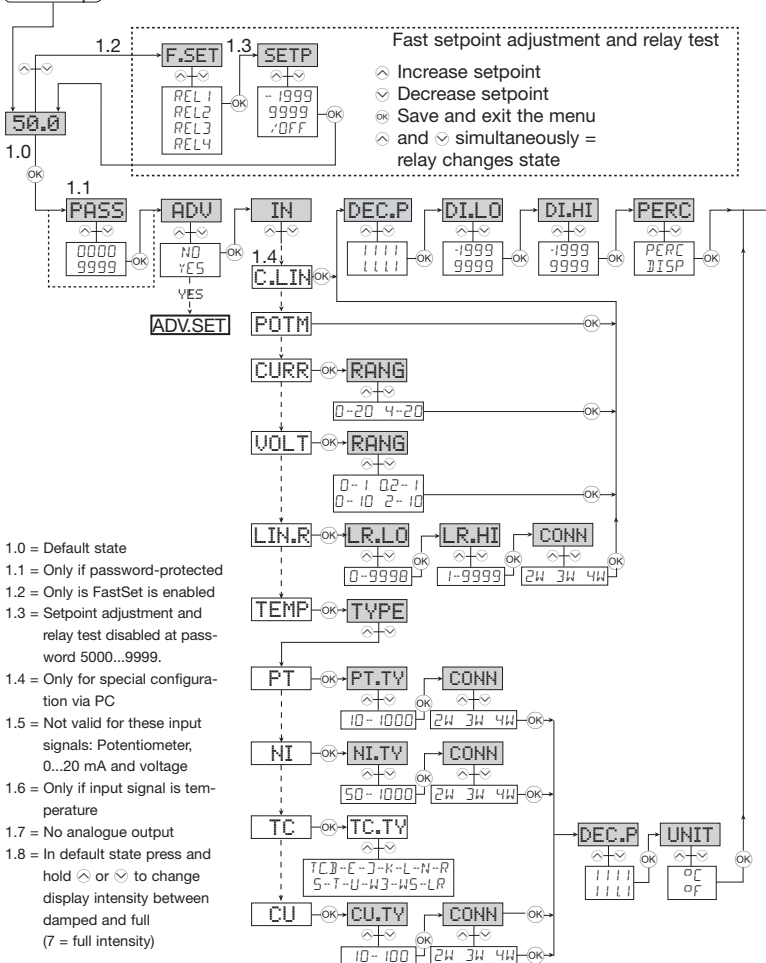

ROUTING DIAGRAM

If no key is activated for 2 minutes, the display returns to default state 1.0 without saving configuration changes.

⬆ Increase value / choose next parameter

⬇ Decrease value / choose previous parameter

⊞ Accept the chosen parameter and go to the next menu

Hold ⊞ Back to previous menu / return to default state 1.0 without saving

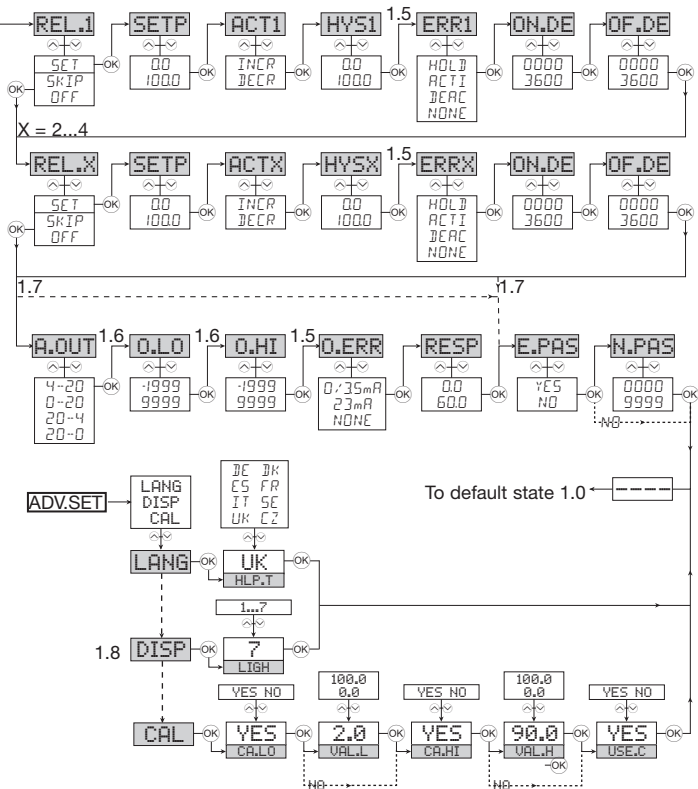

SCROLLING HELP TEXTS

Display in default state xxxx, hardware error:

SE.BR --> SENSOR WIRE BREAKAGE
SE.SH --> SENSOR SHORT CIRCUIT
IN.HI --> INPUT OVERRANGE
IN.LO --> INPUT UNDERRANGE
9.9.9.9 --> DISPLAY OVERRANGE
-1.9.9.9 --> DISPLAY UNDERRANGE
HW.ER --> HARDWARE ERROR
EE.ER --> EEPROM ERROR -
CHECK CONFIGURATION
RA.ER --> RAM MEMORY ERROR
CJ.ER --> CJC SENSOR ERROR

Fastset (Enabled):

F.SET
REL1 --> FAST SET MENU -
REL2 --> SELECT RELAY
REL3
REL4

SETP

xxxx --> RELAY SETPOINT - PRESS OK TO SAVE

Fastset (Disabled):

SETP
xxxx --> RELAY SETPOINT - READ ONLY

Configuration menus:

ADV
YES --> ENTER ADVANCED SETUP MENU?
NO

PASS

xxxx --> SET CORRECT PASSWORD

IN

C.LIN* --> TEXT ENTERED BY USER IN PRESET
CURR --> CURRENT INPUT
VOLT --> VOLTAGE INPUT
POTM --> POTENTIOMETER INPUT
LIN.R --> LINEAR RESISTANCE INPUT
TEMP --> TEMPERATURE SENSOR INPUT

RANG When current selected:

0-20 --> INPUT RANGE IN mA
4-20 --> INPUT RANGE IN mA

RANG When voltage selected:

0-10 --> INPUT RANGE IN VOLT
2-10 --> INPUT RANGE IN VOLT
0.0-1 --> INPUT RANGE IN VOLT
0.2-1 --> INPUT RANGE IN VOLT

DEC.P

1111 --> DECIMAL POINT POSITION
111.1 --> DECIMAL POINT POSITION
11.11 --> DECIMAL POINT POSITION
1.111 --> DECIMAL POINT POSITION

LR.LO

xxxx --> SET RESISTANCE VALUE LOW

LR.HI

xxxx --> SET RESISTANCE VALUE HIGH

DI.LO

xxxx --> DISPLAY READOUT LOW

DI.HI

xxxx --> DISPLAY READOUT HIGH

RELU

PERC --> SET RELAY IN PERCENTAGE
DISP --> SET RELAY IN DISPLAY UNITS

TYPE

CU --> SELECT CU SENSOR TYPE
PT --> SELECT PT SENSOR TYPE
NI --> SELECT NI SENSOR TYPE
TC --> SELECT TC SENSOR TYPE

CU.TY

10 --> SELECT CU SENSOR TYPE
20 --> SELECT CU SENSOR TYPE
50 --> SELECT CU SENSOR TYPE
100 --> SELECT CU SENSOR TYPE

PT.TY

10 --> SELECT PT SENSOR TYPE
20 --> SELECT PT SENSOR TYPE
50 --> SELECT PT SENSOR TYPE
100 --> SELECT PT SENSOR TYPE
200 --> SELECT PT SENSOR TYPE
250 --> SELECT PT SENSOR TYPE
300 --> SELECT PT SENSOR TYPE
400 --> SELECT PT SENSOR TYPE
500 --> SELECT PT SENSOR TYPE
1000 --> SELECT PT SENSOR TYPE

NI.TY

50 --> SELECT NI SENSOR TYPE
100 --> SELECT NI SENSOR TYPE
120 --> SELECT NI SENSOR TYPE
1000 --> SELECT NI SENSOR TYPE

CONN

2W --> SELECT 2-WIRE SENSOR CONNECTION
3W --> SELECT 3-WIRE SENSOR CONNECTION
4W --> SELECT 4-WIRE SENSOR CONNECTION

TC.TY

TC. B --> SELECT TC SENSOR TYPE
TC. E --> SELECT TC SENSOR TYPE
TC. J --> SELECT TC SENSOR TYPE
TC. K --> SELECT TC SENSOR TYPE
TC. L --> SELECT TC SENSOR TYPE
TC. N --> SELECT TC SENSOR TYPE
TC. R --> SELECT TC SENSOR TYPE
TC. S --> SELECT TC SENSOR TYPE
TC. T --> SELECT TC SENSOR TYPE
TC. U --> SELECT TC SENSOR TYPE
TC.W3 --> SELECT TC SENSOR TYPE
TC.W5 --> SELECT TC SENSOR TYPE
TC.LR --> SELECT TC SENSOR TYPE

DEC.P

1111 --> DECIMAL POINT POSITION
111.1 --> DECIMAL POINT POSITION

UNIT

°C --> DISPLAY AND RELAY SETUP IN CELSIUS
°F --> DISPLAY AND RELAY SETUP IN FAHRENHEIT

REL1		RESP	
SET -->	ENTER RELAY 1 SETUP	xxx.x -->	ANALOGUE OUTPUT RESPONSE TIME IN SECONDS
SKIP -->	SKIP RELAY 1 SETUP		
OFF -->	RELAY 1 DISABLED		
SETP		E.PAS	
xxxx -->	RELAY SETPOINT	NO -->	ENABLE PASSWORD PROTECTION
		YES	
ACT1		N.PAS	
INCR -->	ACTIVATE AT INCREASING SIGNAL	xxxx -->	SELECT NEW PASSWORD
DECR -->	ACTIVATE AT DECREASING SIGNAL		
HYS1		ADV MENU:	
xxxx -->	RELAY HYSTERESIS	LANG -->	ENTER LANGUAGE SETUP
		DISP -->	ENTER DISPLAY SETUP
ERR1		CAL -->	PERFORM PROCESS CALIBRATION
HOLD -->	HOLD RELAY AT ERROR		
ACTI -->	ACTIVATE RELAY AT ERROR	HLP.T	
DEAC -->	DEACTIVATE RELAY AT ERROR	DE -->	DE - WAEHLE DEUTSCHEN HILFETEXT
NONE -->	UNDEFINED STATUS AT ERROR	DK -->	DK - VÆLG DANSK HJÆLPETEKST
		ES -->	ES - SELECCIONAR TEXTO DE AYUDA EN ESPAÑOL
ON.DE		FR -->	FR - SELECTIONNER TEXTE D'AIDE EN FRANÇAIS
xxxx -->	RELAY ON-DELAY IN SECONDS	IT -->	IT - SELEZIONARE TESTI DI AIUTO ITALIANI
OF.DE		SE -->	SE - VALJ SVENSK HJALPTEXT
xxxx -->	RELAY OFF-DELAY IN SECONDS	UK -->	UK - SELECT ENGLISH HELPTTEXT
		CZ -->	CZ - VYBER CESKOU NAPOVEDU
RELX (X = 2...4)		LIGH	
SET -->	ENTER RELAY 2 SETUP	xxxx -->	ADJUST DISPLAY LIGHT INTENSITY
SKIP -->	SKIP RELAY 2 SETUP		
OFF -->	RELAY 2 DISABLED	CA.LO	
SETP		YES -->	CALIBRATE INPUT LOW TO PROCESS VALUE?
xxxx -->	RELAY SETPOINT	NO	
ACTX (X = 2...4)		CA.HI	
INCR -->	ACTIVATE AT INCREASING SIGNAL	YES -->	CALIBRATE INPUT HIGH TO PROCESS VALUE?
DECR -->	ACTIVATE AT DECREASING SIGNAL	NO	
HYSX (X = 2...4)		VAL.L	
xxxx -->	RELAY HYSTERESIS	xxxx -->	SET VALUE FOR LOW CALIBRATION POINT
ERRX (X = 2...4)		VAL.H	
HOLD -->	HOLD RELAY AT ERROR	xxxx -->	SET VALUE FOR HIGH CALIBRATION POINT
ACTI -->	ACTIVATE RELAY AT ERROR		
DEAC -->	DEACTIVATE RELAY AT ERROR	USE.C	
NONE -->	UNDEFINED STATUS AT ERROR	YES -->	USE PROCESS CALIBRATED VALUES?
ON.DE		NO	
xxxx -->	RELAY ON-DELAY IN SECONDS		
OF.DE			
xxxx -->	RELAY OFF-DELAY IN SECONDS		
A.OUT			
0-20 -->	OUTPUT RANGE IN mA		
4-20 -->	OUTPUT RANGE IN mA		
20-0 -->	OUTPUT RANGE IN mA		
20-4 -->	OUTPUT RANGE IN mA		
O.LO			
xxxx -->	DISPLAY VALUE FOR OUTPUT LOW		
O.HI			
xxxx -->	DISPLAY VALUE FOR OUTPUT HIGH		
O.ERR			
23 mA -->	NAMUR NE43 UPSCALE AT ERROR		
3,5 mA -->	NAMUR NE43 DOWNSCALE AT ERROR		
0mA -->	DOWNSCALE AT ERROR		
NONE -->	UNDEFINED OUTPUT AT ERROR		



CONFIGURATION / OPERATING



THE FUNCTION KEYS

Documentation for the routing diagram

In general:

When configuring the display you are guided through all parameters, allowing you to choose the settings which fit the application. For each menu there is a scrolling help text which is automatically shown in the display if no key has been activated for appr. 5 seconds.





Configuration is carried out by way of the 3 function keys   and .

 will increase the numerical value or choose the next parameter.  will decrease the numerical value or choose the previous parameter.  will accept the chosen value and go to the next menu. If a function does not exist in the hardware, all parameters belonging to that function will be skipped in order to make configuration as simple as possible. The configuration will not be saved until the end of the menu structure when the display shows ----.

Pressing and holding  will return to the previous menu or go back to the default state (1.0) without saving the changed values or parameters.

If no key is activated for 2 minutes, the display will return to the default state (1.0) without saving the changed values or parameters.

Furhter explanations:

Fast setpoint adjustment and relay test: These menus are interactive and allow you to adjust the setpoints while the display is measuring the input signal. The diodes will then indicate when the relays change state, thus easing the setpoint adjustment in many situations. By activating  and  simultaneously, a relay test will be initiated and the relay will change state. The setpoint adjustment will be saved by a quick press of . Holding down  for more that 0.5 seconds will return the display to the default state (1.0) without changing the setpoint.

Password protection: Using a password will block access to the menu and parameters. There are two levels of password protection. Passwords between 0000 and 4999 allow access to the fast setpoint adjustment and relay test menus (using this password blocks access to all other parts of the menu). Passwords between 5000 and 9999 block access to all parts of the menu, fast setpoint and relay test (current setpoint is still shown). Default password 2008 allows access to all configuration menus.

PROGRAMMING VIA PC

By way of PReset, a simple yet sophisticated PC program, all operational parameters in the 5715 can be quickly configured to suit any application. Furthermore, the PC configuration allows you to set up a customer-defined input type for the input signals current, voltage, resistance and potentiometer. This input type can be defined with special input spans, e.g. 5...12 mA, and customer-defined linearisation with or without offset. The customer-defined input type is saved in the 5715 in the input menu `CLIN`. If the display is later configured by way of the front keys for e.g. temperature input, the input type `CLIN` containing all the original parameters can be subsequently selected. The PC configuration is sent to the display by way of the communications interface USB Loop Link.

Graphic depiction of the relay function setpoint

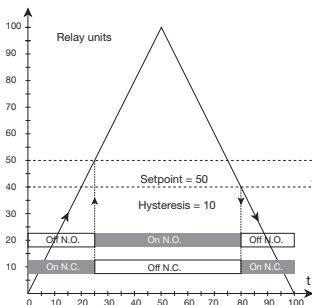

Relay action: Increasing

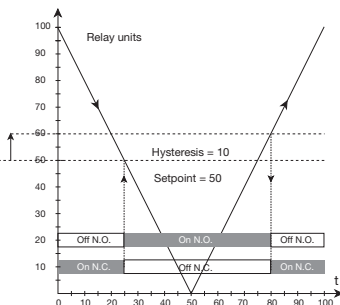

Relay action: Decreasing



Displays Programmable displays with a wide selection of inputs and outputs for display of temperature, volume and weight, etc. Feature linearisation, scaling, and difference measurement functions for programming via PReset software.



Ex interfaces Interfaces for analogue and digital signals as well as HART® signals between sensors / I/P converters / frequency signals and control systems in Ex zone 0, 1 & 2 and for some devices in zone 20, 21 & 22.



Isolation Galvanic isolators for analogue and digital signals as well as HART® signals. A wide product range with both loop-powered and universal isolators featuring linearisation, inversion, and scaling of output signals.



Temperature A wide selection of transmitters for DIN form B mounting and DIN rail devices with analogue and digital bus communication ranging from application-specific to universal transmitters.



Universal PC or front programmable devices with universal options for input, output and supply. This range offers a number of advanced features such as process calibration, linearisation and auto-diagnosis.



- 
 www.preelectronics.fr
 sales@preelectronics.fr
- 
 www.preelectronics.de
 sales@preelectronics.de
- 
 www.preelectronics.es
 sales@preelectronics.es
- 
 www.preelectronics.it
 sales@preelectronics.it
- 
 www.preelectronics.se
 sales@preelectronics.se
- 
 www.preelectronics.co.uk
 sales@preelectronics.co.uk
- 
 www.preelectronics.com
 sales@preelectronics.com
- 
 www.preelectronics.cn
 sales@preelectronics.cn

Head office

Denmark
 PR electronics A/S
 Lerbakken 10
 DK-8410 Rønde

www.preelectronics.com
sales@preelectronics.dk
 tel. +45 86 37 26 77
 fax +45 86 37 30 85



QUALITY SYSTEM AND ENVIRONMENTAL
 MEDICAL MANAGEMENT SYSTEM
 DS/EN ISO 9001
 DS/EN ISO 14001

